



Owner's Manual

Original Instructions

Split Air Conditioner

CONTENTS

Safety precautions	01
Parts name	05
Operation and introduction of remote controller	06
Clean and maintenance	12
Checked items before maintenance	13
Installation notice	14
Installation of indoor unit	16
Test and operation	19
Configuration of connection pipe	20

Thank you for choosing our product.

Please read this Owner's Manual carefully before operation and retain it for future reference.

If you have lost the Owner's Manual, please contact the local agent or visit www.gree.com or send an email to global@cn.gree.com for the electronic version.

NOTE:

Actual product may be different from graphics, please refer to actual products.

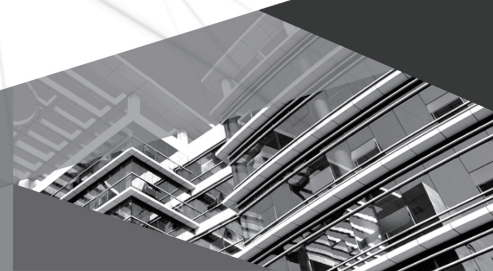

GWC09QBXB-D3DNA5B/I
GWC09QBXB-D3DNB6B/I
GWC09QBXB-D3DNB8B/I
GWC09QBXB-D3DNC2B/I
GWC09QBXB-D3DNC4B/I
GWC09QBXB-D3DNC6B/I
GWC09QBXB-A3DND8B/I
GWC09QBXB-D3DND8B/I
GWC09QBXB-A3DND4B/I
GWC09QBXB-D3DND4B/I
GWH09QBXB-A3DNB2B/I
GWH09QBXB-D3DNB2B/I
GWH09QBXB-D3DNB8B/I
GWH09QBXB-D3DNB6B/I
GWH09QBXB-D3DNC4B/I
GWH09QBXB-D3DNC6B/I
GWH09QBXB-D3DNA5B/I
GWH09QBXB-A3DNA5B/I
GWH09QBXB-A3DND4B/I
GWH09QBXB-D3DND4B/I
GWH09QBXB-D3DND8B/I
GWC12QCXB-D3DNA5B/I
GWC12QCXB-D3DNB2B/I
GWC12QCXB-D3DNB6B/I
GWC12QCXB-D3DNB8B/I
GWC12QCXB-A3DND4B/I
GWC12QCXB-D3DND4B/I
GWC12QCXB-A3DND8B/I
GWC12QCXB-A3DNC2B/I
GWC12QCXB-A3DNC4B/I
GWC12QCXB-D3DNC2B/I
GWC12QCXB-D3DNC4B/I
GWC12QCXB-D3DND6B/I
GWC12QCXB-D3DND8B/I
GWC12QCXB-D3DNC6B/I
GWH12QCXB-D3DNA5B/I
GWH12QCXB-A3DNA5B/I
GWH12QCXB-A3DNB2B/I
GWH12QCXB-A3DNB8B/I

GWH12QCXB-D3DNB8B/I
GWH12QCXB-D3DNB2B/I
GWH12QCXB-D3DNC6B/I
GWH12QCXB-A3DNC4B/I
GWH12QCXB-D3DNC4B/I
GWH12QCXB-D3DNB6B/I
GWH12QCXB-A3DNB6B/I
GWH12QCXB-D3DND8B/I
GWH18QDXD-D3DNA5A/I
GWC18QDXD-D3DNC4A/I
GWC18QDXD-D3DNC2A/I
GWC18QDXD-D3DNB2A/I
GWC18QDXD-D3DNB6A/I
GWC18QDXD-D3DNB8A/I
GWC18QDXD-D3DNC6A/I
GWC18QDXD-D3DND4A/I
GWC18QDXD-D3DND6A/I
GWC18QDXD-D3DND8B/I
GWC18QDXD-D3DNA5A/I
GWH18QDXD-D3DNB2A/I
GWH18QDXD-D3DNB6A/I
GWH18QDXD-D3DNB8A/I
GWH18QDXD-D3DNC6A/I
GWH18QDXD-D3DNC4A/I
GWH18QDXD-D3DND8B/I
GWC24QEXF-D3DNA5C/I
GWC24QEXF-D3DNB6C/I
GWC24QEXF-D3DNB8C/I
GWC24QEXF-D3DNC2C/I
GWC24QEXF-D3DNC4C/I
GWC24QEXF-D3DNC6C/I
GWC24QEXF-D3DND4C/I
GWC24QEXF-D3DND6C/I
GWC24QEXF-D3DND8C/I
GWH24QEXF-D3DNB6C/I
GWH24QEXF-D3DNB2C/I
GWH24QEXF-D3DNB8C/I
GWH24QEXF-D3DNC4C/I
GWH24QEXF-D3DNC6C/I

GWH24QEXF-D3DNA5C/I
GWH24QEXF-D3DND8C/I
GWC30QFXH-D3DNB2A/I
GWC30QFXH-D3DNB4A/I
GWH30QFXH-D3DNB2A/I
GWH30QFXH-D3DNB4A/I
GWC36QFXH-D3DNB2B/I
GWC36QFXH-D3DNB4B/I
GWH36QFXH-D3DNB2B/I
GWH36QFXH-D3DNB4B/I

Explanation of Symbols



WARNING

This symbol indicates the possibility of death or serious injury.



CAUTION

This symbol indicates the possibility of injury or damage to property.

NOTICE

Indicates important but not hazard-related information, used to indicate risk of property damage.

Exception Clauses

Manufacturer will bear no responsibilities when personal injury or property loss is caused by the following reasons.

1. Damage the product due to improper use or misuse of the product;
2. Alter, change, maintain or use the product with other equipment without abiding by the instruction manual of manufacturer;
3. After verification, the defect of product is directly caused by corrosive gas;
4. After verification, the defects are due to improper operation during transportation of product;
5. Operate, repair, maintain the unit without abiding by instruction manual or related regulations;
6. After verification, the problem or dispute is caused by the quality specification or performance of parts and components that produced by other manufacturers;
7. The damage is caused by natural calamities, bad using environment or force majeure.

If it needs to install, move or maintain the air conditioner, please contact dealer or local service center to conduct it at first. Air conditioner must be installed, moved or maintained by appointed unit. Otherwise, it may cause serious damage or personal injury or death.

When refrigerant leaks or requires discharge during installation, maintenance, or disassembly, it should be handled by certified professionals or otherwise in compliance with local laws and regulations.

This appliance is not intended for use by persons (including children) with reduced physical, sensory or mental capabilities or lack of experience and knowledge, unless they have been given supervision or instruction concerning use of the appliance by a person responsible for their safety.

Children should be supervised to ensure that they do not play with the appliance.

FCC WARNING

WARNING: Changes or modifications to this unit not expressly approved by the party responsible for compliance could void the user's authority to operate the equipment.

FCC STATEMENT

This device complies with Part 15 of the FCC Rules. Operation is subject to the following two conditions :

(1) this device may not cause harmful interference, and (2) this device must accept any interference received, including interference that may cause undesired operation.

NOTE: This equipment has been tested and found to comply with the limits for a Class B digital device, pursuant to part 15 of the FCC Rules. These limits are designed to provide reasonable protection against harmful interference in a residential installation. This equipment generates, uses and can radiate radio frequency energy and, if not installed and used in accordance with the instructions, may cause harmful interference to radio communications.

However, there is no guarantee that interference will not occur in a particular installation. If this equipment does cause harmful interference to radio or television reception, which can be determined by turning the equipment off and on, the user is encouraged to try to correct the interference by one or more of the following measures:

- Reorient or relocate the receiving antenna.
- Increase the separation between the equipment and receiver.
- Connect the equipment into an outlet on a circuit different from that to which the receiver is connected.
- Consult the dealer or an experienced radio/TV technician for help.

IC STATEMENT

This device complies with Industry Canada licence exempt RSS standard(s). Operation is subject to the following two conditions: (1) this device may not cause interference, and (2) this device must accept any interference, including interference that may cause undesired operation of the device.

Le présent appareil est conforme aux CNR d'Industrie Canada applicables aux appareils radio exempts de licence. L'exploitation est autorisée aux deux conditions suivantes : (1) l'appareil ne doit pas produire de brouillage, et (2) l'utilisateur de l'appareil doit accepter tout brouillage radioélectrique subi, même si le brouillage est susceptible d'en compromettre le fonctionnement.

IC STATEMENT

This equipment complies with FCC's and IC's RF radiation exposure limits set forth for an uncontrolled environment. The antenna(s) used for this transmitter must be installed and operated to provide a separation distance of at least 20 cm from all persons and must not be collocated or operating in conjunction with any other antenna or transmitter. Installers must ensure that 20cm separation distance will be maintained between the device (excluding its handset) and users.

Cet appareil est conforme aux limites d'exposition au rayonnement RF stipulées par la FCC et l'IC pour une utilisation dans un environnement non contrôlé. Les antennes utilisées pour cet émetteur doivent être installées et doivent fonctionner à au moins 20 cm de distance des utilisateurs et ne doivent pas être placées près d'autres antennes ou émetteurs ou fonctionner avec ceux-ci. Les installateurs doivent s'assurer qu'une distance de 20 cm sépare l'appareil (à l'exception du combiné) des utilisateurs.

Safety precautions



WARNING

Installation

- Installation or maintenance must be performed by qualified professionals.
- The appliance shall be installed in accordance with national wiring regulations.
- According to the local safety regulations, use qualified power supply circuit and circuit breaker.
- All wires of indoor unit and outdoor unit should be connected by a professional.
- Be sure to cut off the power supply before proceeding any work related to electricity and safety.
- Make sure the power supply matches with the requirement of air conditioner.
- Unstable power supply or incorrect wiring may result in electric shock, fire hazard or malfunction. Please install proper power supply cables before using the air conditioner.
- The grounding resistance should comply with national electric safety regulations.
- Air Conditioner should be properly grounded. Incorrect grounding may cause electric shock.
- Do not put through the power before finishing installation.
- Do install the circuit breaker. If not, it may cause malfunction.
- An all-pole disconnection switch having a contact separation of at least 3mm in all poles should be connected in fixed wiring.
- Circuit breaker should be included magnet buckle and heating buckle function. It can protect the overload and circuit-short.
- The ground resistance shall be in conformity with the requirements of NEC and CEC.
- Installation must be per-

Safety precautions



CAUTION

Installation

formed in accordance with the requirement of NEC and CEC by authorized personnel only.

- Instructions for installation and use of this product are provided by the manufacturer.
- Select a location which is out of reach for children and far away from animals or plants. If it is unavoidable, please add the fence for safety purpose.
- The indoor unit should be installed close to the wall.
- Don't use unqualified power cord.
- If the length of power connection wire is insufficient, please contact the supplier for a new one.
- The appliance must be positioned so that the plug is accessible.
- For the air conditioner with plug, the plug should be re-

achable after finishing installation.

- For the air conditioner without plug, a circuit breaker must be installed in the line.
- The yellow-green wire in air conditioner is grounding wire, which can't be used for other purposes.
- The air conditioner is the first class electric appliance. It must be properly grounded with specialized grounding device by a professional. Please make sure it is always grounded effectively, otherwise it may cause electric shock.
- The temperature of refrigerant circuit will be high, please keep the interconnection cable away from the

Safety precautions



WARNING

Operation and Maintenance

- This appliance can be used by children aged from 8 years and above and persons with reduced physical, sensory or mental capabilities or lack of experience and knowledge if they have been given supervision or instruction concerning use of the appliance in a safe way and understand the hazards involved.
- Children shall not play with the appliance.
- Cleaning and user maintenance shall not be made by children without supervision.
- If the supply cord is damaged, it must be replaced by the manufacturer, its service agent or similarly qualified persons in order to avoid a hazard.
- Do not connect air conditioner to multi-purpose socket. Otherwise, it may cause fire hazard.
- Do disconnect power supply when cleaning air conditioner. Otherwise, it may cause electric shock.
- Do not wash the air conditioner with water to avoid electric shock.
- Do not spray water on indoor unit. It may cause electric shock or malfunction.
- Do not repair air conditioner by yourself. It may cause electric shock or damage. Please contact dealer when you need to repair air conditioner.
- After removing the filter, do not touch fins to avoid injury.
- Do not extend fingers or objects into air inlet or air outlet. It may cause personal injury or damage.

Safety precautions



CAUTION

Operation and Maintenance

- Do not spill water on the remote controller, otherwise the remote controller may be broken.
- Do not use fire or hair dryer to dry the filter to avoid deformation or fire hazard.
- Do not block air outlet or air inlet. It may cause malfunction.
- Do not step on top panel of outdoor unit, or put heavy objects. It may cause damage or personal injury.
- When below phenomenon occurs, please turn off air conditioner and disconnect power immediately, and then contact the dealer or qualified professionals for service.
 - Power cord is overheating or damaged.
 - There's abnormal sound during operation.
 - Circuit breaker trips off frequently.
- Air conditioner gives off burning smell.
- Indoor unit is leaking.





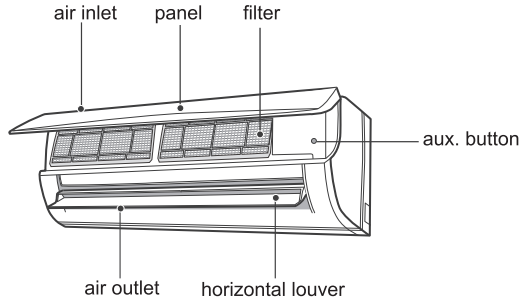



Parts name

Indoor Unit



- If remote controller is lost or damaged, please use aux. button to turn on or turn off the air conditioner. The operation in details is as below: As shown in the figure, open panel and press aux. button to turn off the air conditioner. When the air conditioner is turned on, it will operate under auto mode.

Display

Heat mode		 R:red indicator (only for heat model)
Cool mode		 W:white indicator
Dry mode		 G:green indicator  O:orange indicator
Temp. indicator	26	
Power indicator		

NOTE

- This is the general introduction and the color of indicator is only for reference. Please refer to the actual display.
- Display content may be different from the actual. Please refer to the actual display.

Operation and introduction of remote controller

Buttons on remote controller

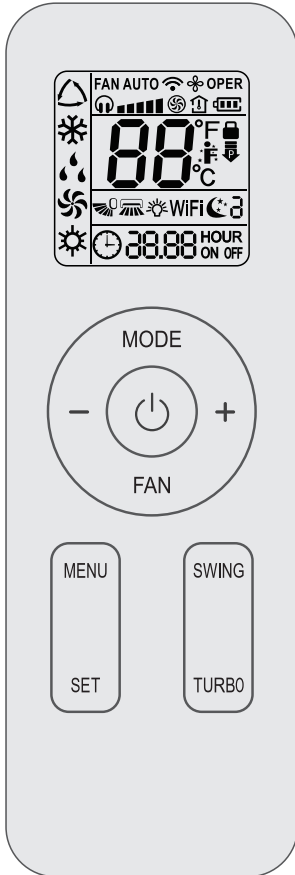

Introduction for icons on display screen

	I feel	
	Set fan speed	
	Turbo mode	
	Send signal	
Operation mode		Auto mode
		Cool mode
		Dry mode
		Fan mode
		Heat mode
		Sleep mode
	Light	
	Power limiting operation	
	X-FAN function	
	Indoor ambient temp.	
	Clock	
	Set temperature	
	WiFi function	
	Set time	
	TIMER ON / TIMER OFF	
	Left & right swing	
	Up & down swing	
	Child lock	
	Quiet	

Introduction for buttons on remote controller

NOTE

- This is a general use remote controller. It could be used for the air conditioner with multifunction. For the functions which the model doesn't have, if press the corresponding button on the remote controller, the unit will keep the original running status.
- After putting through the power, the air conditioner will give out a sound. Power indicator "⏻" is ON. After that, you can operate the air conditioner by using remote controller.
- Under on status, pressing the button on the remote controller, the signal icon "📶" on the display of remote controller will blink once and the air conditioner will give out a sound, which means the signal has been sent to the air conditioner.

⏻ button

Press this button to turn on the unit. Press this button again to turn off the unit.

MODE button

Press this button to select your required operation mode.



- When selecting auto mode, air conditioner will operate automatically according to ambient temperature. Set temperature can't be adjusted and will not be displayed as well. Press "FAN" button can adjust fan speed. Press "SWING" button can adjust fan blowing angle.
- When selecting cool mode, air conditioner will operate under cool mode. Press "+" or "-" button to adjust set temperature. Press "FAN" button to adjust fan speed. Press "SWING" button to adjust fan blowing angle.
- When selecting dry mode, the air conditioner operates at low speed under dry mode. Under dry mode, fan speed can't be adjusted. Press "SWING" button to adjust fan blowing angle.
- When selecting fan mode, the air conditioner will only blow fan, no cooling and no heating. Press "FAN" button to adjust fan speed. Press "SWING" button to adjust fan blowing angle.

- When selecting heat mode, the air conditioner operates under heat mode. Press "+" or "-" button to adjust set temperature. Press "FAN" button to adjust fan speed. Press "SWING" button to adjust fan blowing angle.

NOTE

- For preventing cold air, after starting up heat mode, indoor unit will delay 1~5 minutes to blow air (Actual delay time depends on indoor ambient temperature).
- Set temperature range from remote controller: 16~30°C(61-86°F).
- This mode indicator is not available for some models.
- Cooling only unit won't receive heat mode signal. If setting heat mode with remote controller, press "⏻" button can't start up the unit.

FAN button

This button is used for setting Fan Speed in the sequence that goes from AUTO, , , , , to , then back to Auto.

NOTE

- Under AUTO speed, air conditioner will select proper fan speed automatically according to factory default setting.
- It's low fan speed under dry mode.
- X-FAN function: Holding fan speed button for 2s in cool or dry mode, the icon "⊗" is displayed and the indoor fan will continue operation for a few minutes in order to dry the indoor unit even though you have turned off the unit. After energization, X-FAN OFF is defaulted. X-FAN is not available in auto, fan or heat mode.
This function indicates that moisture on evaporator of indoor unit will be blown after the unit is stopped to avoid mould.
- Having set X-FAN function on: After turning off the unit by pressing "⏻" button, indoor fan will continue running for a few minutes at low speed. In this period, hold fan speed button for 2s to stop indoor fan directly. Having set X-FAN function off: After turning off the unit by pressing "⏻" button, the complete unit will be off directly.
- If equipped with the product of 4 kinds of fan speed, when setting "🔊", "■", the unit will work in low speed; when setting "■■", "■■■", the unit will work in medium speed; when setting "■■■■", "■■■■■", the unit will work in high speed.

- / + button

Press "+" or "-" button once increase or decrease

set temperature 1°C(°F). Holding "+" or "-" button, 2s later, set temperature on remote controller will change quickly. On releasing button after setting is finished, temperature indicator on indoor unit will change accordingly. (Temperature can't be adjusted under auto mode)

When setting TIMER ON, TIMER OFF or CLOCK, press "+" or "-" button to adjust time. (Refer to CLOCK, TIMER ON, TIMER OFF functions).

MENU button

Press this button to select submenu function and then press "SET" button to set the function status of submenu. The submenu can be selected circularly as follows:

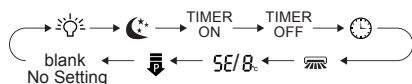

NOTE

- Some menu's function may be unavailable under different models.

Light function

When selecting light function, light icon "☀️" flashes for 5s; press "SET" button within 5s to turn off display light on indoor unit and "☀️" icon on remote controller disappears. Press "SET" button again within 5s to turn on display light and "☀️" icon is displayed.

Sleep function

When selecting sleeping function, sleeping icon "🌙" flashes for 5s; press "SET" button within 5s can select Sleep 1 (🌙1), Sleep 2 (🌙2), Sleep 3 (🌙3) and cancel Sleep circularly.

- Sleep 1 is Sleep mode 1, in Cool modes; sleep status after run for one hour, the main unit setting temperature will increase 1°C, two hours, setting temperature increased 2°C, then the unit will run at this setting temperature; In Heat mode: sleep status after run for one hour, the setting temperature will decrease 1°C, two hours, setting temperature will decrease 2°C, then the unit will run at this setting temperature.
- Sleep 2 is sleep mode 2, that is air conditioner will run according to the presetting a group of sleep temperature curve.
- Sleep 3-the sleep curve setting under Sleep mode by DIY;

(1)Under Sleep 3 mode, press "Turbo" button for a long time, remote controller enters into user individualization sleep setting status, at this time, the time of remote controller will display "1hour", the setting

temperature "88" will display the corresponding temperature of last setting sleep curve and blink (The first entering will display according to the initial curve setting value of original factory);

(2)Adjust "+" and "-" button, could change the corresponding setting temperature, after adjusted, press "Turbo" button for confirmation;

(3) At this time, 1hour will be automatically increased at the timer position on the remote control, (that are "2hours" or "3hours" or "8hours"), the place of setting temperature "88" will display the corresponding temperature of last setting sleep curve and blink;

(4) Repeat the above step (2)-(3) operation, until 8 hours temperature setting finished, sleep,curve setting finished, at this time, the remote controller will resume the original timer display; temperature display will resume to original setting temperature.

- Sleep3- the sleep curve setting under Sleep mode by DIY could be inquired:

The user could accord to sleep curve setting method to inquire the presetting sleep curve, enter into user individualization sleep setting status, but do not change the temperature, press "Turbo" button directly for confirmation. Note: In the above presetting or enquiry procedure, if continuously within 10s, there is no button pressed, the sleep curve setting within 10s, there is no button pressed, the sleep curve setting status will be automatically quit and resume to display the original displaying. In the presetting or enquiry procedure, press "⏸" button, "MODE" button, the sleep curve setting or enquiry status will quit similarly.

NOTE

- If equipped with the product with one kind of sleeping mode only, set Sleep 1 (🌙1) or Sleep 3 (🌙3) to activate sleeping function.

TIMER ON function

TIMER ON function can set the time for timer on. Under TIMER ON function status, "🕒" icon disappears and the word "ON" on remote controller blinks. Press "+" or "-" button to adjust TIMER ON setting. After each pressing "+" or "-" button TIMER ON setting will increase or decrease 1min. Hold "+" or "-" button, 2s later, the time will change quickly until reaching your required time. Press "SET" button to confirm it within 5S. The word "ON" will stop blinking.

Cancel TIMER ON: Press "MENU" button to TIMER ON function and the characters "ON" flashes on the remote controller; press "SET" button until the characters "ON" disappears.

TIMER OFF function

TIMER OFF function can set the time for timer off. Under TIMER OFF function status, "🕒" icon disappears and the word "OFF" on remote controller blinks. Press "+" or "-" button to adjust TIMER

OFF setting. After each pressing "+" or "-" button TIMER OFF setting will increase or decrease 1min. Hold "+" or "-" button, 2s later, the time will change quickly until reaching your required time, press "SET" button to confirm it within 5S. The word "OFF" will stop blinking.

Cancel TIMER OFF: Press "MENU" button to TIMER OFF function and the characters "OFF" flashes on the remote controller; press "SET" button until the characters "OFF" disappears.

CLOCK function

CLOCK function can set clock time. Under CLOCK function status, "🕒" icon on remote controller will blink. Press "+" or "-" button within 5s to set clock time. Each pressing of "+" or "-" button, clock time will increase or decrease 1 min. If hold "+" or "-" button, 2s later, time will change quickly. Release this button when reaching your required time, press "SET" button to confirm it within 5S. The "🕒" icon will stop blinking.

Left & right swing function

When selecting left & right swing function, left & right swing icon "🌀" flashes for 5s; press "SET" button within 5s to select left & right swing angle. Fan blow angle can be selected circularly as below:

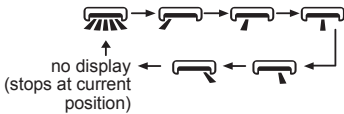

NOTE

- The function is only available for some models.

Energy-saving function

Under cooling mode, when selecting energy-saving function, energy-saving function icon "5E" flashes for 5s; press "SET" button within 5s to turn on or turn off energy-saving function. When energy-saving function is started up, "SE" will be shown on remote controller, and air conditioner will adjust the set temperature automatically according to ex-factory setting to reach to the best energy-saving effect. Press "SET" button again to exit energy-saving function.

8°C-heating function

Under heating mode, when selecting 8°C-heating function, 8°C-heating icon "8°C" flashes for 5s; press "SET" button within 5s to turn on or turn off

8°C-heating. When 8°C-heating is started up, "8°C" will be shown on remote controller, and the air conditioner keep the heating status at 8°C. Press "SET" button again to exit 8°C-heating function.

NOTE

- Under °F temperature display, the remote controller will display 46°F heating.

Power limiting function

Power limiting function is for limiting the power of the whole unit. When selecting power limiting function, power limiting icon "⏸" flashes for 5s; press "SET" button within 5s and the remote controller will circularly display as follows:



- Maximum power limited under the ⏸ mode is lower than that of ⏸ mode.
- If the current power is lower than the maximum power of ⏸ mode, then the power will not be limited after entering into such mode.
- For the model with one outdoor unit and two indoor units, if any one of indoor units enters into power limiting function, the outdoor unit will enter into the set limiting power mode of indoor unit; when two indoor units enter into power limiting mode, then the power of outdoor unit will be limited according to the lower power of the two indoor units.

NOTE

- The function is only available for some models.

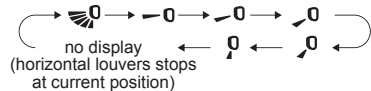

SWING button

Press this button can select up & down swing angle. Fan blow angle can be selected circularly as below:





- When selecting "🌀", air conditioner is blowing fan automatically. Horizontal louver will automatically swing up & down at maximum angle.
- When selecting "↕", "↔", "↙", "↘", air conditioner is blowing fan at fixed position. Horizontal louver will stop at the fixed position.
- Hold "🌀" button above 2s to set your required swing angle. When reaching your required angle, release the button.

NOTE



- Press this button continuously for more than 2s, the main unit will swing back and forth from up to down, and then loosen the button, the unit present position of guide louver will be kept immediately.
- Under up and down swing mode, when the status is switched from off to , if press this button again 2s later,  status will switch to off status directly; if press this button again within 2s, the change of swing status will also depend on the circulation sequence stated above.

TURBO button

Under COOL or HEAT mode, press this button to turn to quick COOL or quick HEAT mode. " " icon is displayed on remote controller. Press this button again to exit turbo function and " " icon will disappear. If start this function, the unit will run at super-high fan speed to cool or heat quickly so that the ambient temperature approaches the preset temperature as soon as possible.

Function introduction for combination buttons

Child lock function

Press "+" and "-" simultaneously to turn on or turn off child lock function. When child lock function is on, " " icon is displayed on remote controller. If you operate the remote controller, the " " icon will blink three times without sending signal to the unit.

Temperature display switchover function

Under OFF status, press "-" and "MODE" buttons simultaneously to switch temperature display between °C and °F.

Auto clean function

Under unit off status, hold "MODE" and "FAN" buttons simultaneously for 5s to turn on or turn off the auto clean function. When the auto clean function is turned on, indoor unit displays "CL". During the auto clean process of evaporator, the unit will perform fast cooling or fast heating. There may be some noise, which is the sound of flowing liquid or thermal expansion or cold shrinkage. The air con-

ditioner may blow cool or warm air, which is a normal phenomenon. During cleaning process, please make sure the room is well ventilated to avoid affecting the comfort.

NOTE

- The auto clean function can only work under normal ambient temperature. If the room is dusty, clean it once a month; if not, clean it once every three months. After the auto clean function is turned on, you can leave the room. When auto clean is finished, the air conditioner will enter standby status.
- This function is only available for some models.

WiFi function

Press "MODE" and "TURBO" button simultaneously to turn on or turn off WiFi function. When WiFi function is turned on, the "WiFi" icon will be displayed on remote controller; Long press "MODE" and "TURBO" buttons simultaneously for 10s, remote controller will send WiFi reset code and then the WiFi function will be turned on. WiFi function is defaulted ON after energization of the remote controller.

NOTE

- This function is only available for some models.

Ambient temperature display function

Press "SWING" and "SET" buttons simultaneously, you can see indoor ambient temperature on indoor unit's display and the " " icon will be displayed on remote controller. The setting on remote controller is selected circularly as below:

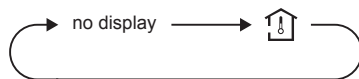

Adjustable temperature under auto mode

The remote controller defaulted that the set temperature can't be adjusted and it won't be displayed under AUTO mode; when pressing "+" and "SET" buttons simultaneously under off status for consecutive 5s, the set temperature can be adjusted under AUTO mode. After setting is succeeded, the set temperature on the remote controller flashes for 3 times.

Night mode

Under cooling or heating mode, when turning on sleep mode and turn to low speed or quiet notch, the outdoor unit would enter into night mode.

NOTE

- When you feel that the cooling and heating effect is poor, please press "FAN" button to other fan speed or press "MENU" button twice and press "SET" button to cancel sleep mode, then outdoor unit will exit the night mode.
- The night mode can only work under normal ambient temperature.
- This function is only available for some models

Replacement of batteries in remote controller

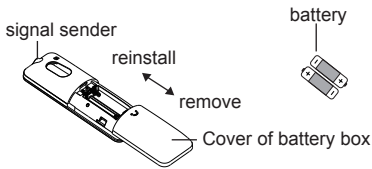

1. Press the back side of remote controller marked with "☺", as shown in the fig, and then push out the cover of battery box along the arrow direction.
2. Replace two 7# (AAA 1.5V) dry batteries, and make sure the position of "+" polar and "-" polar are correct.
3. Reinstall the cover of battery box.

NOTICE

- During operation, point the remote control signal sender at the receiving window on indoor unit.
- The distance between signal sender and receiving window should be no more than 8m, and there should be no obstacles between them.
- Signal may be interfered easily in the room where there is fluorescent lamp or wireless telephone; remote controller should be close to indoor unit during operation.
- Replace new batteries of the same model when replacement is required.
- When you don't use remote controller for a long time, please take out the batteries.
- If the display on remote controller is fuzzy or there's no display, please replace batteries.

Clean and maintenance

⚠ WARNING

- Turn off the air conditioner and disconnect the power before cleaning the air conditioner to avoid electric shock.
- Do not wash the air conditioner with water to avoid electric shock.
- Do not use volatile liquid to clean the air conditioner.
- Do not use liquid or corrosive detergent to clean the appliance and do not splash water or other liquid onto it, otherwise, it may damage the plastic components, even cause electric shock.

Clean surface of indoor unit

When the surface of indoor unit is dirty, it is recommended to use a soft dry cloth or wet cloth to wipe it.

NOTICE

- Do not remove the panel when cleaning it.

Clean filter

1. Open panel

Pull out the panel to a certain angle as shown in the fig.

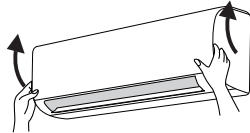

2. Remove filter

Remove the filter as indicated in the fig.

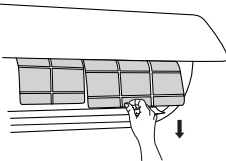

3. Clean filter

- Use dust catcher or water to clean the filter.
- When the filter is very dirty, use the water (below 45°C) to clean it, and then put it in a shady and cool place to dry.

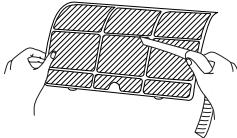

4. Install filter

Install the filter and then close the panel cover tightly.

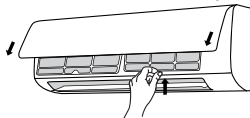

⚠ WARNING

- The filter should be cleaned every three months. If there is much dust in the operation environment, clean frequency can be increased.
- After removing the filter, do not touch fins to avoid injury.
- Do not use fire or hair dryer to dry the filter to avoid deformation or fire hazard.

NOTICE: Checking before use-season

1. Check whether air inlets and air outlets are blocked.
2. Check whether air switch, plug and socket are in good condition.
3. Check whether filter is clean.
4. Check whether mounting bracket for outdoor unit is damaged or corroded. If yes, please contact dealer.
5. Check whether drainage pipe is damaged.

NOTICE: Checking after use-season

1. Disconnect power supply.
2. Clean filter and indoor unit's panel.
3. Check whether mounting bracket for outdoor unit is damaged or corroded. If yes, please contact dealer.

Notice for recovery

1. Many packing materials are recyclable materials. Please dispose them in appropriate recycling unit.
2. If you want to dispose the air conditioner, please contact local dealer or consultant service center for the correct disposal method.

Error Code

When air conditioner status is abnormal, temperature indicator on indoor unit will blink to display corresponding error code. Please refer to below list for identification of error code.

Error code	Troubleshooting
U8, H6, H3, E1, E5, E6, E8	It can be eliminated after restarting the unit. If not, please contact qualified professionals for service.
C5, F0, F1, F2	Please contact qualified professionals for service.

NOTE

- If there're other error codes, please contact qualified professionals for service.

Checked items before maintenance

General phenomenon analysis

Please check below items before asking for maintenance. If the malfunction still can't be eliminated, please contact local dealer or qualified professionals.

Phenomenon	Check items	Solution
Indoor unit can't receive remote controller's signal or remote controller has no action.	Whether it's interfered severely (such as static electricity, stable voltage?)	Pull out the plug. Reinsert the plug after about 3min, and then turn on the unit again.
	Whether remote controller is within the signal receiving range?	Signal receiving range is 8m.
	Whether there are obstacles?	Remove obstacles.
	Whether remote controller is pointing at the receiving window?	Select proper angle and point the remote controller at the receiving window on indoor unit.
	Is sensitivity of remote controller low; fuzzy display or no display?	Check the batteries. If the power of batteries is too low, please replace them.
	No display when operating remote controller?	Check whether remote controller appears to be damaged. If yes, replace it.
No air emitted from indoor unit	Fluorescent lamp in room?	Take the remote controller close to indoor unit. Turn off the fluorescent lamp and then try it again.
	Air inlet or air outlet of indoor unit is blocked?	Eliminate obstacles.
	Under heating mode, indoor temperature is reached to set temperature?	After reaching to set temperature, indoor unit will stop blowing out air.
Air conditioner can't operate	Heating mode is turned on just now?	In order to prevent blowing out cold air, indoor unit will be started after delaying for several minutes, which is a normal phenomenon.
	Power failure?	Wait until power recovery.
	Is plug loose?	Reinsert the plug.
	Air switch trips off or fuse is burnt out?	Ask professional to replace air switch or fuse.
	Wiring has malfunction?	Ask professional to replace it.
	Unit has restarted immediately after stopping operation?	Wait for 3min, and then turn on the unit again.
Mist is emitted from indoor unit's air outlet	Whether the function setting for remote controller is correct?	Reset the function.
	Indoor temperature and humidity is high?	Because indoor air is cooled rapidly. After a while, indoor temperature and humidity will decrease and mist will disappear.

Phenomenon	Check items	Solution
Odours are emitted	Whether there's odour source, such as furniture and cigarette, etc.	Eliminate the odour source. Clean the filter.
Set temperature can't be adjusted	Unit is operating under auto mode?	Temperature can't be adjusted under auto mode. Please switch the operation mode if you need to adjust temperature.
	Your required temperature exceeds the set temperature range?	Set temperature range: 16°C~30°C (61°F~86°F).
Cooling (heating) effect is not good.	Voltage is too low?	Wait until the voltage resumes normal.
	Filter is dirty?	Clean the filter.
	Set temperature is in proper range?	Adjust temperature to proper range.
	Door and window are open?	Close door and window.
Air conditioner operates abnormally	Whether there's interference, such as thunder, wireless devices, etc.	Disconnect power, put back power, and then turn on the unit again.
"Water flowing" noise	Air conditioner is turned on or turned off just now?	The noise is the sound of refrigerant flowing inside the unit, which is a normal phenomenon.
Cracking noise	Air conditioner is turned on or turned off just now?	This is the sound of friction caused by expansion and or contraction of panel or other parts due to the change of temperature.

WARNING

- When below phenomenon occurs, please turn off air conditioner and disconnect power immediately, and then contact the dealer or qualified professionals for service.
 - Power cord is overheating or damaged.
 - There's abnormal sound during operation.
 - Air switch trips off frequently.
 - Air conditioner gives off burning smell.
 - Indoor unit is leaking.
- Do not repair or refit the air conditioner by yourself.
- If the air conditioner operates under abnormal conditions, it may cause malfunction, electric shock or fire hazard.

Installation notice

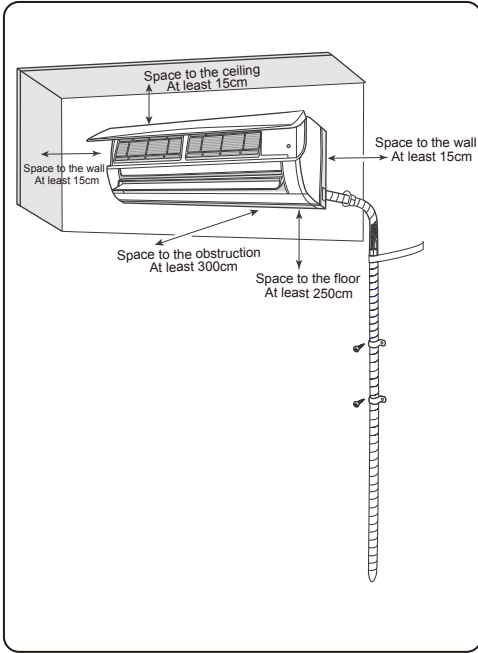

■ Safety precautions for installing and relocating the unit

To ensure safety, please be mindful of the following precautions.

⚠ WARNING

- **When installing or relocating the unit, be sure to keep the refrigerant circuit free from air or substances other than the specified refrigerant.**

Any presence of air or other foreign substance in the refrigerant circuit will cause system pressure rise or compressor rupture, resulting in injury.

- **When installing or moving this unit, do not charge the refrigerant which is not comply with that on the nameplate or unqualified refrigerant.**

Otherwise, it may cause abnormal operation, wrong action, mechanical malfunction or even serious safety accident.

- **When refrigerant needs to be recovered during relocating or repairing the unit, be**

⚠ WARNING

sure that the unit is running in cooling mode. Then, fully close the valve at high pressure side (liquid valve). About 30-40 seconds later, fully close the valve at low pressure side (gas valve), immediately stop the unit and disconnect power. Please note that the time for refrigerant recovery should not exceed 1 minute.

If refrigerant recovery takes too much time, air may be sucked in and cause pressure rise or compressor rupture, resulting in injury.

- **During refrigerant recovery, make sure that liquid valve and gas valve are fully closed and power is disconnected before detaching the connection pipe.**

If compressor starts running when stop valve is open and connection pipe is not yet connected, air will be sucked in and cause pressure rise or compressor rupture, resulting in injury.

- **When installing the unit, make sure that connection pipe is securely connected before the compressor starts running.**

If compressor starts running when stop valve is open and connection pipe is not yet connected, air will be sucked in and cause pressure rise or compressor rupture, resulting in injury.

- **Prohibit installing the unit at the place where there may be leaked corrosive gas or flammable gas.**

If there is leaked gas around the unit, it may cause explosion and other accidents.

- **Do not use extension cords for electrical connections. If the electric wire is not long enough, please contact a local service center authorized and ask for a proper electric wire.**

Poor connections may lead to electric shock or fire.

- **Use the specified types of wires for electrical connections between the indoor and outdoor units. Firmly clamp the wires so that their terminals receive no external stresses.**

Electric wires with insufficient capacity, wrong wire connections and insecure wire terminals may cause electric shock or fire.

■ Tools for installation

- | | | |
|-----------------|--------------------|-------------------------|
| ① Level meter | ⑦ Open-end wrench | ⑫ Universal meter |
| ② Screw driver | ⑧ Pipe cutter | ⑬ Inner hexagon spanner |
| ③ Impact drill | ⑨ Leakage detector | ⑭ Measuring tape |
| ④ Drill head | ⑩ Vacuum pump | |
| ⑤ Pipe expander | ⑪ Pressure meter | |
| ⑥ Torque wrench | | |

NOTICE

- Please contact the local agent for installation.
- Don't use unqualified power cold.

■ Selection of installation location

Basic requirement

Installing the unit in the following places may cause malfunction. If it is unavoidable, please consult the local dealer:

- 1.The place with strong heat sources, vapors, flammable or explosive gas, or volatile objects spread in the air.
- 2.The place with high-frequency devices (such as welding machine, medical equipment).
- 3.The place near coast area.
- 4.The place with oil or fumes in the air.
- 5.The place with sulfureted gas.
- 6.Other places with special circumstances.
- 7.The appliance shall not be installed in the laundry.
- 8.It's not allowed to be installed on the unstable or motive base structure (such as truck) or in the corrosive environment (such as chemical factory).

Indoor unit

- 1.There should be no obstruction near air inlet and air outlet.
- 2.Select a location where the condensation water can be dispersed easily and won't affect other people.
- 3.Select a location which is convenient to connect the outdoor unit and near the power socket.
- 4.Select a location which is out of reach for children.
- 5.The location should be able to withstand the weight of indoor unit and won't increase noise and vibration.
- 6.The appliance must be installed 2.5m above floor.
- 7.Don't install the indoor unit right above the electric appliance.
- 8.Please try your best to keep way from fluorescent lamp.

Safety precaution

- 1.Must follow the electric safety regulations when installing the unit.
- 2.According to the local safety regulations, use qualified power supply circuit and air switch.
- 3.Make sure the power supply matches with the requirement of air conditioner. Unstable power supply or incorrect wiring or malfunction. Please install proper power supply cables before using the air conditioner.
- 4.Properly connect the live wire, neutral wire and grounding wire of power socket.
- 5.Be sure to cut off the power supply before proceeding any work related to electricity and safety.
- 6.Do not put through the power before finishing installation.

■ Requirements for electric connection

- 7.If the supply cord is damaged, it must be replaced by the manufacturer, its service agent or similarly qualified persons in order to avoid a hazard.
- 8.The temperature of refrigerant circuit will be high, please keep the interconnection cable away from the copper tube.
- 9.The appliance shall be installed in accordance with national wiring regulations.

Grounding requirement

- 1.The air conditioner is the first class electric appliance. It must be properly grounded with specialized grounding device by a professional. Please make sure it is always grounded effectively, otherwise it may cause electric shock.
- 2.The yellow-green wire in air conditioner is grounding wire, which can't be used for other purposes.
- 3.The grounding resistance should comply with national electric safety regulations.
- 4.The appliance must be positioned so that the plug is accessible.
- 5.An all-pole disconnection switch having a contact separation of at least 3mm in all poles should be connected in fixed wiring.

Installation of indoor unit

Step 1:

Choose installation location

Recommend the installation location to the client and then confirm it with the client.

Step 2:

Install wall-mounting frame

1. Hang the wall-mounting frame on the wall; adjust it in horizontal position with the level meter and then point out the screw fixing holes on the wall.
2. Drill the screw fixing holes on the wall with impact drill (the specification of drill head should be the same as the plastic expansion particle) and then fill the plastic expansion particles in the holes.
3. Fix the wall-mounting frame on the wall with tapping screws and then check if the frame is firmly installed by pulling the frame. If the plastic expansion particle is loose, please drill another fixing hole nearby.

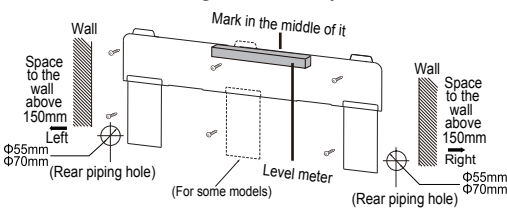

Step 3:

Open piping hole

1. Choose the position of piping hole according to the direction of outlet pipe. The position of piping hole should be a little lower than the wall-mounted frame, shown as below.

NOTE

- The wall panel is for illustrative purposes only, please refer to the actual installation.
- Please refer to the actual circumstances for the number of screws and the position of screws.

2. When installation is finished, pull the mounting plate with hand to confirm whether it is fixed tightly. The force distribution for all screws should be uniform.
3. Open a piping hole with the diameter of $\phi 55$ or $\phi 70$ on the selected outlet pipe position. In order to drain smoothly, slant the piping hole on the wall slightly downward to the outdoor side with the gradient of $5-10^\circ$.

NOTE

- Pay attention to dust prevention and take relevant safety measures when opening the hole.

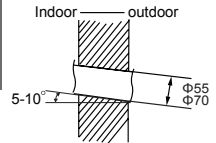

Step 4:

Outlet pipe

1. The pipe can be led out in the direction of right, rear right, left or rear left.

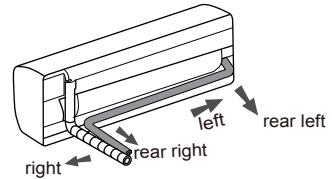

2. When select leading out the pipe from left or right, please cut off the corresponding hole on the bottom case.

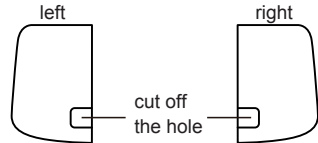

Step 5:

Connect the pipe of indoor unit

1. Aim the pipe joint at the corresponding bellmouth.
2. Pretighten the union nut with hand.

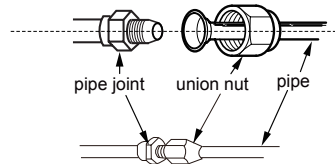

3. Adjust the torque force by referring to the following sheet. Place the open-end wrench on the pipe joint and place the torque wrench on the union nut. Tighten the union nut with torque wrench.

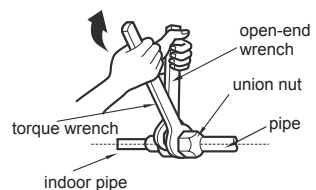

Hex nut diameter	Tightening torque (N.m)
1/4"	15~20
3/8"	30~40
1/2"	45~55
5/8"	60~65
3/4"	70~75

4. Wrap the indoor pipe and joint of connection pipe with insulating pipe, and then wrap it with tape.

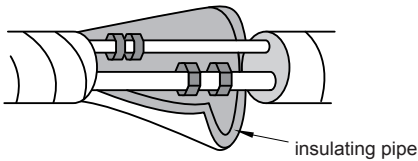

Step 6: Install drain hose

1. Connect the drain hose to the outlet pipe of indoor unit.

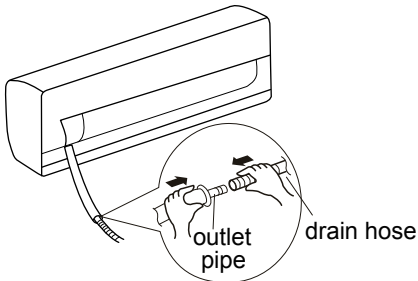

2. Bind the joint with tape.

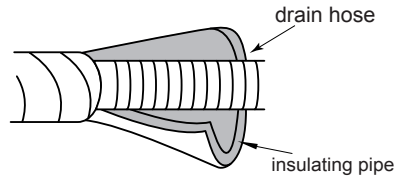
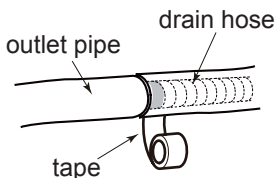

NOTE

- Add insulating pipe in the indoor drain hose in order to prevent condensation.
- The plastic expansion particles are not provided.

Step 7: Connect wire of indoor unit

NOTICE

- All wires of indoor unit and outdoor unit should be connected by a professional.
- If the length of power connection wire is insufficient, please contact the supplier for a new one. Avoid extending the wire by yourself.
- For the air conditioner with plug, the plug should be reachable after finishing installation.
- For the air conditioner without plug, an air switch must be installed in the line. The air switch should be all-pole parting and the contact parting distance should be more than 3mm.

1. Open the panel, remove the screw on the wiring cover and then take down the cover.

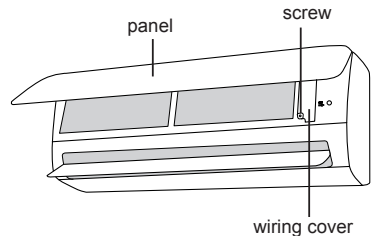

2. Make the power connection wire go through the cable-cross hole at the back of indoor unit and then pull it out from the front side.

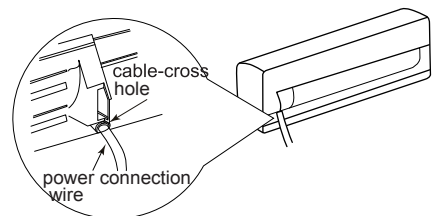

- Remove the wire clip; connect the power connection wire to the wiring terminal according to the color; tighten the screw and then fix the power connection wire with wire clip.

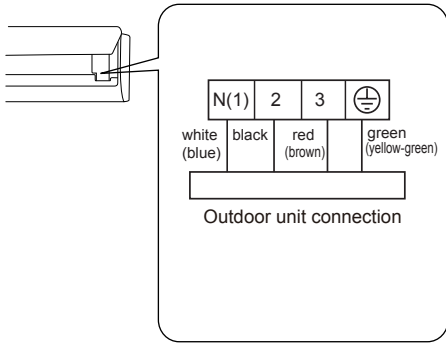

NOTICE

- The wiring board is for reference only, please refer to the actual one.

- Put wiring cover back and then tighten the screw.
- Close the panel.

**Step 8:
Bind up pipe**

- Bind up the connection pipe, power cord and drain hose with the band.

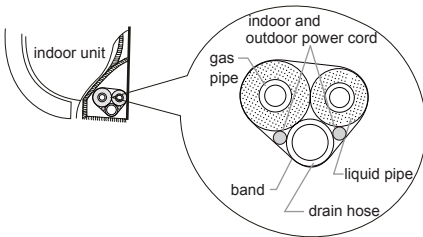

- Reserve a certain length of drain hose and power cord for installation when binding them. When binding to a certain degree, separate the indoor power and then separate the drain hose.

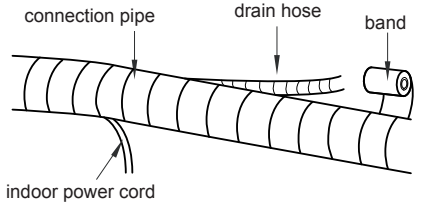

- Bind them evenly.
- The liquid pipe and gas pipe should be bound separately at the end.

NOTICE

- The power cord and control wire can't be crossed or winding.
- The drain hose should be bound at the bottom.

**Step 9:
Hang the indoor unit**

- Put the bound pipes in the wall pipe and then make them pass through the wall hole.
- Hang the indoor unit on the wall-mounting frame.
- Stuff the gap between pipes and wall hole with sealing gum.
- Fix the wall pipe.
- Check if the indoor unit is installed firmly and closed to the wall.

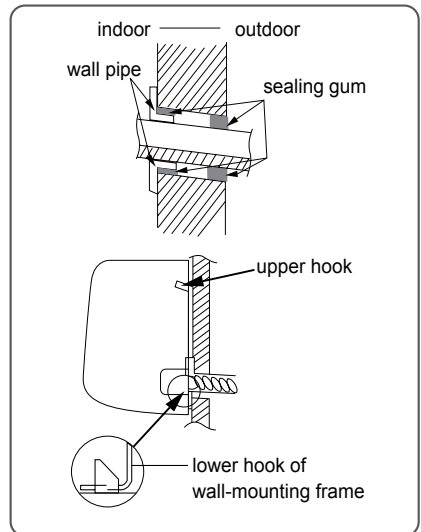

NOTICE

- Do not bend the drain hose too excessively in order to prevent blocking.

Test and operation

■ Check after installation

- Check according to the following requirement after finishing installation.

Items to be checked	Possible malfunction
Has the unit been installed firmly?	The unit may drop, shake or emit noise.
Have you done the refrigerant leakage test?	It may cause insufficient cooling(heating) capacity.
Is heat insulation of pipeline sufficient?	It may cause condensation and water dripping.
Is water drained well?	It may cause condensation and water dripping.
Is the voltage of power supply according to the voltage marked on the nameplate?	It may cause malfunction or damage the parts.
Is electric wiring and pipeline installed correctly?	It may cause malfunction or damage the parts.
Is the unit grounded securely?	It may cause electric leakage.
Does the power cord follow the specification?	It may cause malfunction or damage the parts.
Is there any obstruction in the air inlet and outlet?	It may cause insufficient cooling(heating) capacity.
The dust and sundries caused during installation are removed?	It may cause malfunction or damage the parts.
The gas valve and liquid valve of connection pipe are open completely?	It may cause insufficient cooling (heating) capacity.
Is the inlet and outlet of piping hole been covered?	It may cause insufficient cooling (heating) capacity or waste electricity.

■ Test operation

1. Preparation of test operation

- The client approves the air conditioner.
- Specify the important notes for air conditioner to the client.

2. Method of test operation

- Put through the power, press "⏻" button on the remote controller to start operation.
- Press MODE button to select AUTO, COOL, DRY, FAN and HEAT to check whether the operation is normal or not.
- If the ambient temperature is lower than 16°C(61°F), the air conditioner can't start cooling.

Configuration of connection pipe

1. Standard length of connection pipe: 5m, 7.5m, 8m.
2. Min. length of connection pipe is 3m.
3. Max. length of connection pipe is shown as below.

Max. length of connection pipe

Cooling capacity	Max. length of connection pipe(m)
5000Btu/h (1465W)	15
7000Btu/h (2051W)	15
9000Btu/h (2637W)	15
12000Btu/h (3516W)	20
18000Btu/h (5274W)	25
24000Btu/h (7032W)	25
28000Btu/h (8204W)	30
36000Btu/h (10548W)	30
42000Btu/h (12306W)	30
48000Btu/h (14064W)	30

4. The additional refrigerant oil and refrigerant charging required after prolonging connection pipe.

- After the length of connection pipe is prolonged for 10m at the basis of standard length, you should add 5ml of refrigerant oil for each additional 5m of connection pipe.
- The calculation method of additional refrigerant charging amount(on the basis of liquid pipe):
Additional refrigerant charging amount = prolonged length of liquid pipe × additional refrigerant charging amount per meter
- Basing on the length of standard pipe, add refrigerant according to the requirement as shown in the table. The additional refrigerant charging amount per meter is different according to the diameter of liquid pipe. See the following sheet.

Additional refrigerant charging amount for R22, R407C, R410A and R134a

Outdoor unit throttle	Cooling and heating(g/m)	20	50	120	120	250	350
	Cooling only(g/m)	15	15	30	60	250	350
Piping size	Gas pipe	3/8" or 1/2"	5/8" or 3/4"	3/4" or 7/8"	1" or 1 1/4"	-	-
	Liquid pipe	1/4"	1/4" or 3/8"	1/2"	5/8"	3/4"	7/8"

Pipe expanding method

NOTICE

Improper pipe expanding is the main cause of refrigerant leakage. Please expand the pipe according to the following steps:

A: Cut the pipe

- Confirm the pipe length according to the distance of indoor unit and outdoor unit.
- Cut the required pipe with pipe cutter.

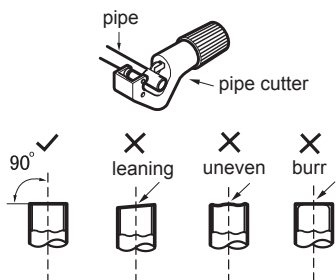

B: Remove the burrs

- Remove the burrs with shaper and prevent the burrs from getting into the pipe.

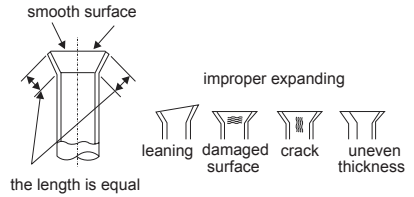
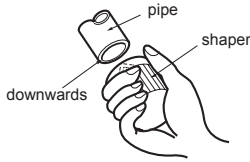

C: Put on suitable insulating pipe

D: Put on the union nut

- Remove the union nut on the indoor connection pipe and outdoor valve; install the union nut on the pipe.

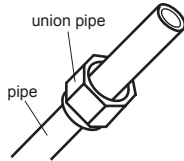

E: Expand the port

- Expand the port with expander.

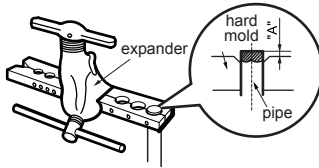

NOTICE

- "A" is different according to the diameter, please refer to the sheet below:

Outer diameter (mm)	A(mm)	
	Max	Min
Φ6 - 6.35(1/4")	1.3	0.7
Φ9 - 9.52(3/8")	1.6	1.0
Φ12-12.7(1/2")	1.8	1.0
Φ15.8-16(5/8")	2.4	2.2

F: Inspection

- Check the quality of expanding port. If there is any blemish, expand the port again according to the steps above.

Working temperature range

For some models:

	Indoor side DB/WB(C/°F)	Outdoor side DB/WB(C/°F)
Maximum cooling	26.7/19.4 (80/67)	48/24 (118/75)
Maximum heating	26.7/- (80/-)	24/18 (75/65)

NOTE

- The operating temperature range (outdoor temperature) for cooling is -18°C(0°F)~48°C(118°F); for heat pump unit is -25°C(-13°F) ~ 48°C(118°F).

For some models:

	Indoor side DB/WB(C/°F)	Outdoor side DB/WB(C/°F)
Maximum cooling	26.7/19.4 (80/67)	50/24 (122/75)
Maximum heating	26.7/- (80/-)	24/18 (75/65)

NOTE

- The operating temperature range (outdoor temperature) for cooling is -20°C(-4°F)~50°C(122°F); for heat pump unit is -25°C(-13°F) ~ 50°C(122°F).



Classic Air Conditioners, INC.

Add: 7101 NW 43rd St, Miami, FL 33166

Tel: 305-477-8880

E-mail: info@refricenter.net

Web: www.refricenter.net



600005065584